

GEARMORE INC.

SEEDER/SPREADERS TRAILER MOUNT

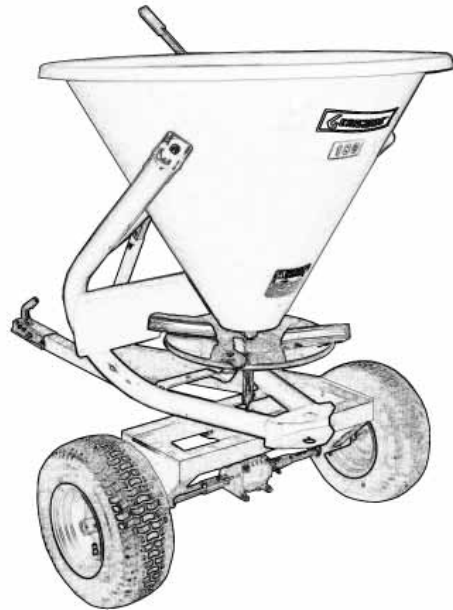

**Assembly, Operation,
Service & Parts Manual
For Models PTP180-P & PTP300-P**

March 2009

TABLE OF CONTENTS

	PAGE
Introduction.....	1
Preparation Checklist	2
Safety Decals.....	3
Safety Information.....	4
General Information	5
Assembly	6 - 9
Pull Type Spreader Use	10
Adjusting the Spread	11
Spreading Chart.....	12
Adjustment.....	13
Adjusting Spreader Vanes.....	13
Features & Option	14
Lubrication & Service.....	15
Replacement of Spreader Vanes.....	15
Operation	16
Spreading in Fields.....	17
Parts Breakdowns.....	18 - 19
Parts Lists	20 - 21
Limited Warranty	22

INTRODUCTION

We would like to thank you for purchasing a Gearmore product and we assure you that you have made a good choice, as now you have a very high quality machine. Please follow all instructions contained in this manual for a long and trustworthy machine life.

Know your controls. Read this manual and the manual provided with your tractor before operating your equipment. Keep this manual handy for ready reference. Learn how to stop the tractor engine and spreader quickly in case of an emergency. **DO NOT** allow adults without proper instructions or children to operate machinery. Require all operators to read this manual carefully and become acquainted with all adjustments and operating procedures before attempting to operate the equipment. Replacement manuals can be obtained from your selling dealer.



It is IMPORTANT to read this manual carefully before operating the spreader!

The equipment you have purchased has been carefully engineered and manufactured to provide dependable and satisfactory use. Like all mechanical products, it will require cleaning and upkeep. Lubricate the unit as specified. Please observe all safety information in this manual and safety decals on the equipment.

For service, your authorized dealer has trained mechanics, genuine service parts, and the necessary tools and equipment to handle all of your service needs.

Use only genuine service parts. Substitute parts will void the warranty and may not meet standards required for safe and satisfactory operation. Record the model number and serial number of your equipment in the warranty page of this manual.

Throughout this manual, the term **IMPORTANT** is used to indicate that failure to observe procedures can cause damage to equipment. The terms **CAUTION**, **WARNING** and **DANGER** are used in conjunction with the Safety-Alert Symbol, (a triangle with an exclamation mark), to indicate the degree of hazard for items of personal safety.



This Safety-Alert Symbol indicates a hazard and means ATTENTION! BECOME ALERT! YOUR SAFETY IS INVOLVED!



DANGER

Indicates an imminently hazardous situation that, if not avoided, will result in death or serious injury.



WARNING

Indicates a potentially hazardous situation that, if not avoided, could result in death or serious injury, and includes hazards that are exposed when guards are removed.



CAUTION

Indicates a potentially hazardous situation that, if not avoided, may result in minor or moderate injury.

IMPORTANT

Indicates that failure to observe can cause damage to equipment.

NOTE

Indicates helpful information.

PREPARATION CHECKLIST



THIS CHECKLIST TO REMAIN IN OWNER'S MANUAL

IT IS YOUR RESPONSIBILITY TO COMPLETE THE PROCEDURES LISTED

BELOW BEFORE OPERATING THE SPREADER

Preparation Check List

- 1. Implement is completely assembled.
- 2. Inspect for damage and loose or missing parts
- 3. All decals in place and readable.
- 4. All fittings and drive components are secure.
- 5. Overall condition good.
- 6. Check hopper for any foreign objects.
- 7. Operator has been instructed on the safe and proper use of the implement.
- 8. Lubrication - See *Lubrication & Maintenance* Section

The purpose of this manual is to assist you in operating and maintaining your spreader for years of service. Read it carefully. The information and instructions in this manual have been compiled from extensive field experience and engineering data. Some information may be general in nature due to unknown and varying operating conditions. However, through experience and these instructions, you should be able to develop procedures suitable to your particular situation.

The illustrations and data used in this manual were current at the time of printing, but because we maintain an ongoing program of product improvement, we reserve the right to make improvements in design or changes in specifications without incurring any obligation to install them on units previously sold. Because of the possibility that some photographs in this manual were taken of prototype models, production models may vary in some detail.

All information, illustrations and specifications in this manual are based on the latest information available at the time of publication. The right is reserved to make changes at any time without notice.

RETAIL CUSTOMER'S WARRANTY RESPONSIBILITY

It is the Retail Customer and/or Operator's responsibility to read the Operator's Manual, to operate, lubricate, maintain and store the product in accordance with all instructions and safety procedures. Failure of the operator to read the Operator's Manual is a misuse of this equipment. It is the Retail Customer and/or Operator's responsibility to inspect the product and to have any part(s) repaired or replaced when continued operation would cause damage or excessive wear to other parts or cause a safety hazard. It is the Retail Customer's responsibility to deliver the product to the authorized dealer from whom he purchased it, for service or replacement of defective parts which are covered by warranty. Repairs to be submitted for warranty consideration must be made within thirty (30) days of failure. It is the Retail Customer's responsibility for any cost incurred by the dealer for traveling to or hauling of the product for the purpose of performing a warranty obligation or inspection.

SAFETY DECALS



ATTENTION!

Be sure that the safety labels are readable. Clean them up using a cloth, water and soap. Replace the damaged labels placing them in the right position, as subsequently described.

The safety signs on the machine supply the most important indications; their observance helps your safeness.



1. **ATTENTION!** Before making any operation on the machine, stop the engine of the tractor or of the self-moving means, remove the key, put on the parking brake and read carefully the operator's manual.



2. **ATTENTION! - DANGER!** Possible throwing of material and/or objects, please do not stop or come up to the machine. Keep a safety distance of 50 feet, at least, from the machine.



3. **ATTENTION! - DANGER!** Forbidden to go inside the hopper or to transport somebody with the machine.



4. **ATTENTION!** Use the individual Protection Devices, as required.

Where to place the safety decals on the machine



SAFETY INFORMATION



OPERATIONAL SAFETY

It is absolutely necessary to empty the hopper before lowering the spreader to the ground.

Guards and safety shields are for your protection. **DO NOT** operate equipment unless they are in place.

Read and observe all safety decals on the tractor and spreader.

NEVER allow anyone, other than the operator, within 25' of machine while in operation.

DO NOT stop or start suddenly when going uphill or downhill. Avoid operation on steep slopes.

Be alert for holes in terrain and other hidden hazards. **ALWAYS** drive slowly over rough ground.

Reduce speed on slopes and in sharp turns to prevent tipping or loss of control. Be careful when changing directions on slopes.

Take all possible precautions when leaving tractor unattended: Shift into neutral, set parking brake, stop engine and remove key from ignition.

GENERAL INFORMATION

MACHINE INFORMATION:

The models introduced in this manual have been designed and made exclusively allowing the distribution of solid, granular fertilizers and of seeds in the field.

A different use is considered improper. Any arbitrary modification made to this machine relieve the manufacturer from any responsibility for damages or lesions, also serious, that can be caused to the operators, to third parties or to things.

NAME PLATE:

On the hopper of every machine a name plate is fixed showing the model, the number of series and the year of construction of the machine.

When some spare parts are required, it is always necessary to refer to the type of machine, to the serial number and to the manufacturing year.



Placement of the Name Plate

CHARACTERISTICS OF THE MACHINE:

The pull-type spreader model PTP has a distributor of fertilizer completely in stainless steel equipped with a spreader disc with four adjustable vanes in four different positions, in order to obtain the maximum spreading precision and uniformity in the distribution, depending on the kind of product that must be spread.



Distributor Disc

ASSEMBLY

HOW TO ASSEMBLE - STEP BY STEP:

STEP 1: Install the 2 grease zerks as shown.

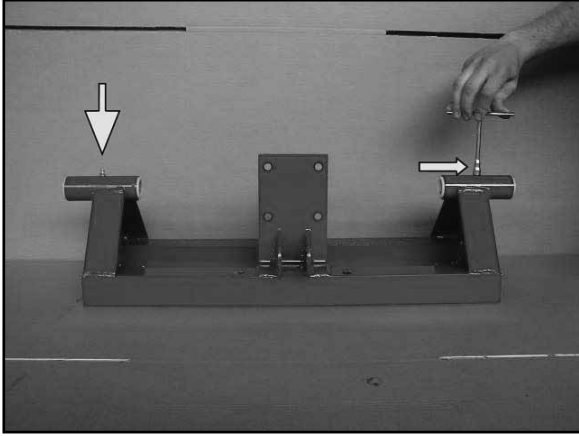

STEP 4: Set the left shaft into the bushing



STEP 2: Put the washer (25 x 35 x 1) into the right axle.

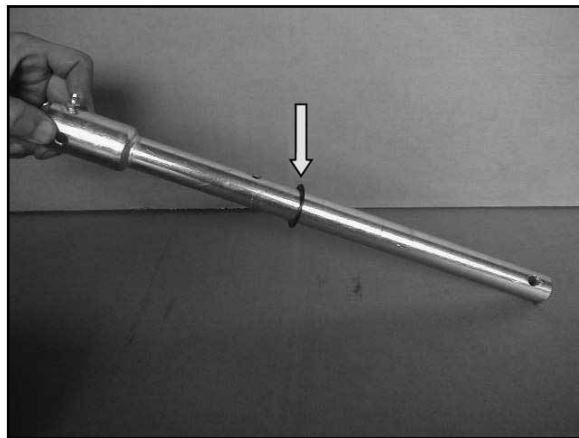

STEP 5: Set the gearbox into the left shaft first.

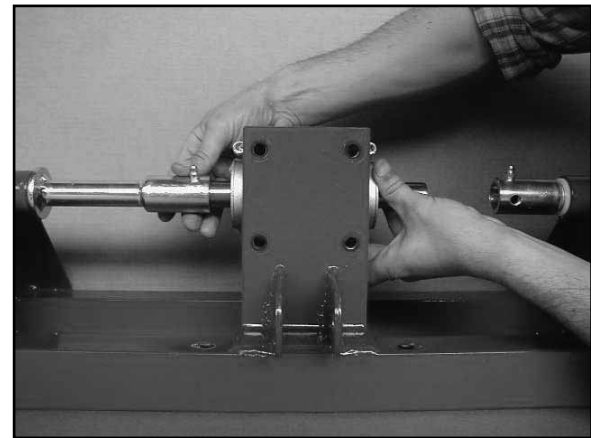

STEP 3: Set the right shaft into the bushing as shown.

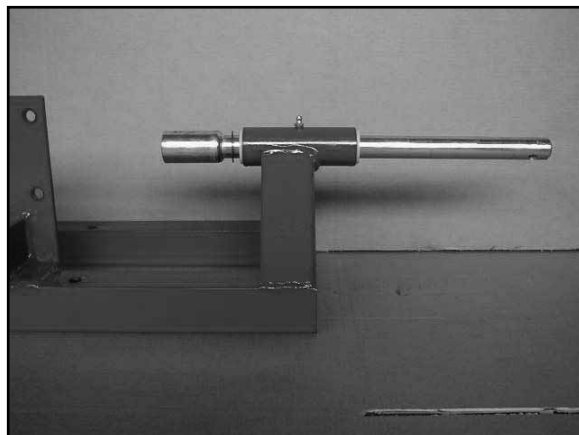

STEP 6: Set the right shaft into the gearbox.

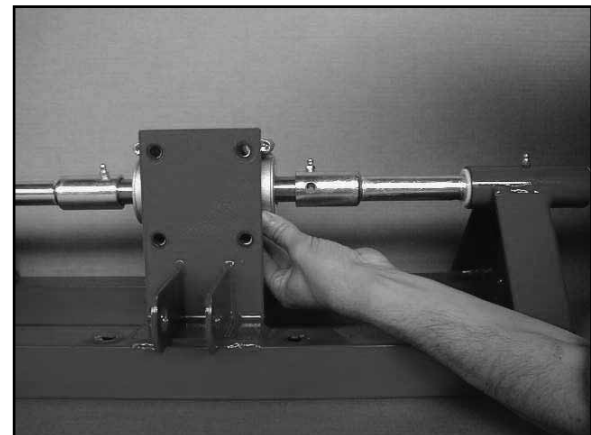

ASSEMBLY

HOW TO ASSEMBLE - STEP BY STEP (Continued):

STEP 7: Set the input-drive key (8mm dia.) into the right shaft.

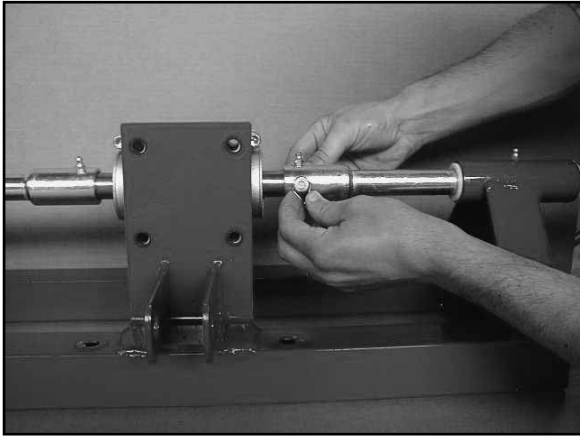

STEP 8: Tighten the gearbox with the 4 bolts (10 x 100) and their M10 self-locking nuts.

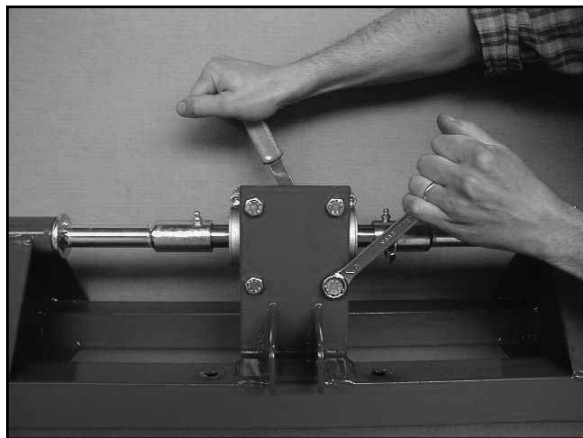

STEP 9: Set the 5 x 40 pin as shown.

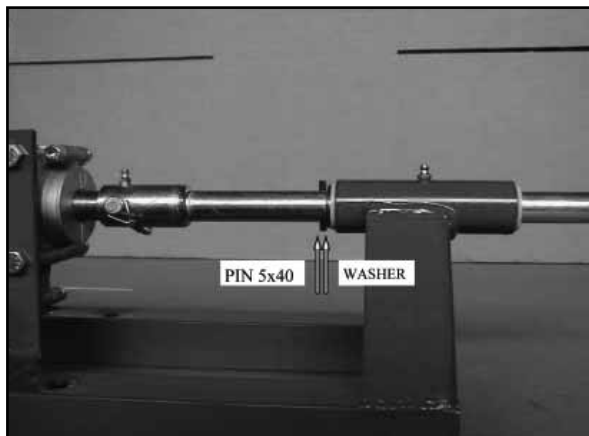

STEP 10: Lay the frame as shown.

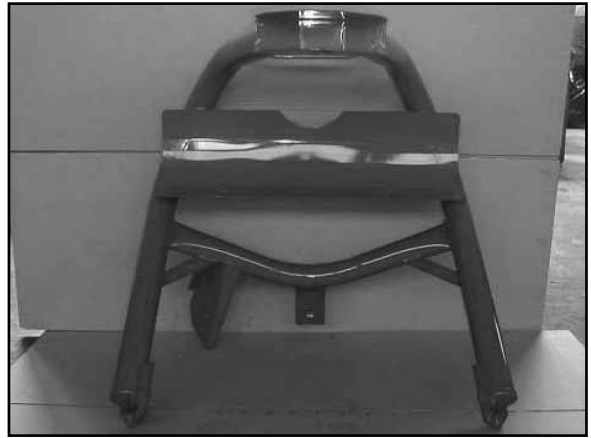

STEP 11: Set the axle frame on the hopper frame, tightening it with the 4 ea. 10 x 70 bolts, the 4 ea. 10 x 20 washers and the 4 ea. 10 x 30 nuts.

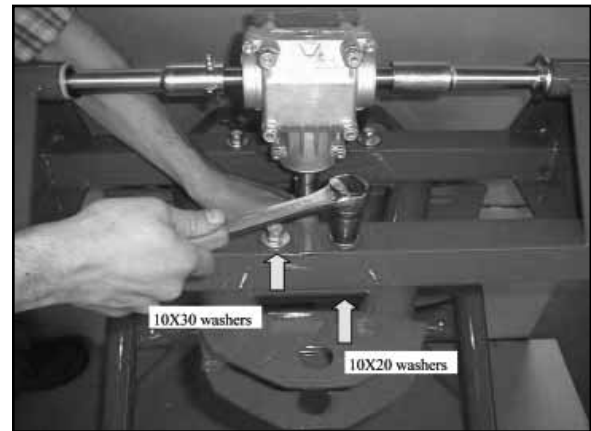

STEP 12: Set the wheels in the axle with 8 x 50 bolts and M8 self-locking nuts.



ASSEMBLY

HOW TO ASSEMBLE - STEP BY STEP (Continued):

STEP 13: With 22 x 80 bolts and M22 self-locking nuts, bolt the tongue and support brace in place.

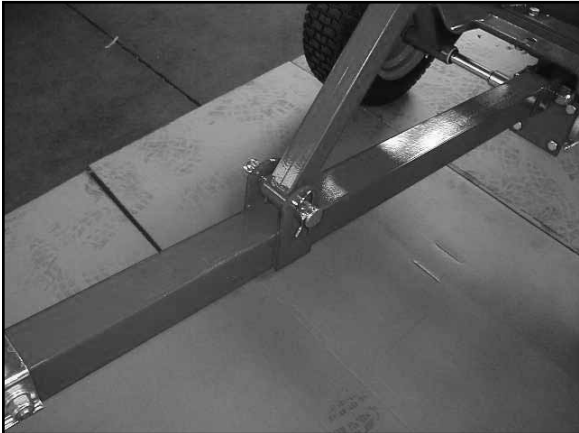

STEP 14: Set the telescopic axle with its 8 x 40 bolt and M8 wing nut as shown.



STEP 15 *very important!* Set the output shaft into the spreading disc, then drive 1 ea. 8 x 40 and 1 ea. 5 x 40 pins into the agitator, **BEFORE** setting the shaft into the gearbox.

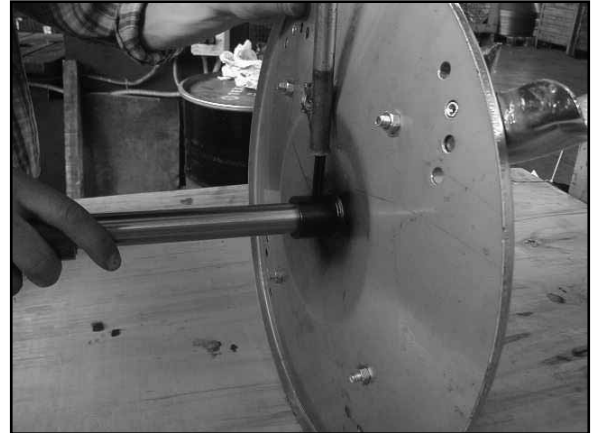

STEP 16: Set the assembled disc into the gearbox.



ASSEMBLY

HOW TO ASSEMBLE - STEP BY STEP (Continued):

STEP 17: Tighten the output shaft as shown.

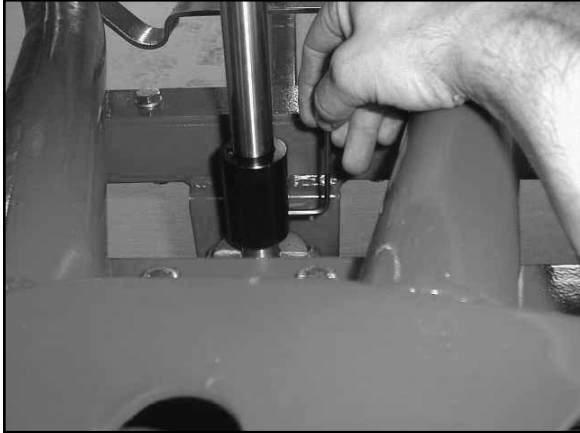

STEP 18: Place the PVC hopper in frame and install the 2 opening levers.

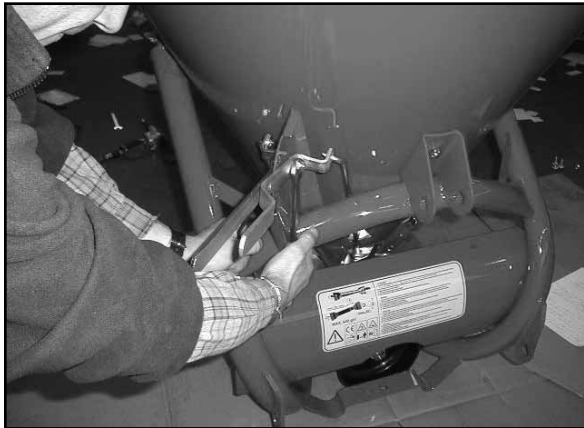

STEP 19: Drill and bolt hopper in place.
IMPORTANT: Make sure the bottom of the hopper is centered on the shaft.



PULL TYPE SPREADER USE



ATTENTION! Before use, please check that gears are adequately greased (see lubrication section).



ATTENTION! During the use of the machine, please be sure that for a radius of 50 feet, there are not any persons or animals. If somebody comes up, please stop immediately the tractor engine.

RECOMMENDATIONS FOR A CORRECT DISTRIBUTION:

- Please always test the lbs. per acre that you wish to spread before starting to work.
- Use a fertilizer in perfect conditions, a humid fertilizer could not be spread uniformly and correctly.
- Avoid spreading the fertilizer on windy days, in order to improve the uniformity of the distribution.

CONNECTIONS:

The pull type spreaders model PTP can be hitched to every type of tractor or ATV/quad with a 2" ball.

To make the connection, it is necessary to put the ball hitch in the coupler on the pull type spreader, locking it pushing the lock handle towards the bottom.

Check and regulate the length of the regulation tongue rod, so that the spreader disc is, as parallel as possible, to the ground, in order to get a uniform and regular distribution of the fertilizer.

Unscrew the locking bolt, as shown with the arrow in the picture below and move the rod in the optimal position, in correspondence of the present holes and lock the bolt in the new position..

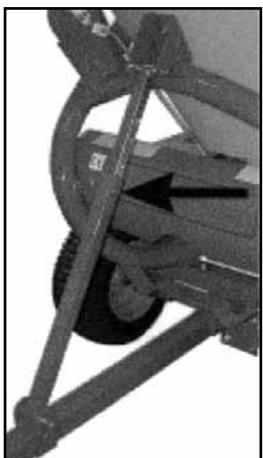

Shaft Regulation Bar

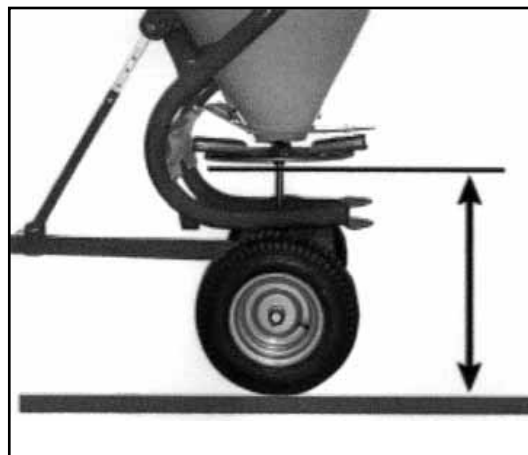

Correct Position of the Spreading Disc

ADJUSTING THE SPREAD

The fertilizer spreading is regulated through the regulation lever that moves the opening section on the bottom of the hopper.

In order to carry out the regulation, after having consulted the spreading table, according to the type of product to spread and to the spreader speed, it is necessary to move the lever "A" along the graduated scale "E" and blocking it in the chosen position with the pin "D".

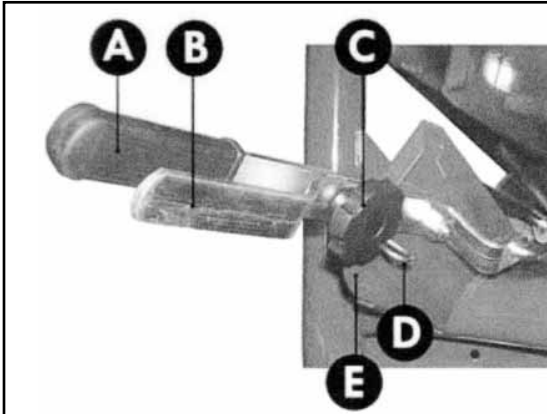

SPREADING CHART FOR FERTILIZER										SPREADING CHART FOR SEED									
TRACTOR WORKING SPEED (MPH)		QUANTITY SPREAD PER HOUR (LBS/ACR)								TRACTOR WORKING SPEED (MPH)		QUANTITY SPREAD PER HOUR (LBS/ACR)							
1	2	3	4	5	6	7	8	9	10	1	2	3	4	5	6	7	8	9	10
LARGE GRANULAR FERTILIZER 2.5	120	240	360	480	600	720	840	960	1080	1200	1320	1440	1560	1680	1800	1920	2040	2160	2280
MEDIUM GRANULAR FERTILIZER 2.5	120	240	360	480	600	720	840	960	1080	1200	1320	1440	1560	1680	1800	1920	2040	2160	2280
SMALL GRANULAR FERTILIZER 2.5	120	240	360	480	600	720	840	960	1080	1200	1320	1440	1560	1680	1800	1920	2040	2160	2280
LIQUID FERTILIZER 2.5	120	240	360	480	600	720	840	960	1080	1200	1320	1440	1560	1680	1800	1920	2040	2160	2280
CRISTAL FERTILIZER 2.5	120	240	360	480	600	720	840	960	1080	1200	1320	1440	1560	1680	1800	1920	2040	2160	2280
MEAL FERTILIZER 2.5	120	240	360	480	600	720	840	960	1080	1200	1320	1440	1560	1680	1800	1920	2040	2160	2280
BRICK-CLAY FERTILIZER 2.5	120	240	360	480	600	720	840	960	1080	1200	1320	1440	1560	1680	1800	1920	2040	2160	2280

See this chart on the next page

In order to spread from both sides (ref. I), "A" and "B" levers must be in the same position, connected through grip handle "C".

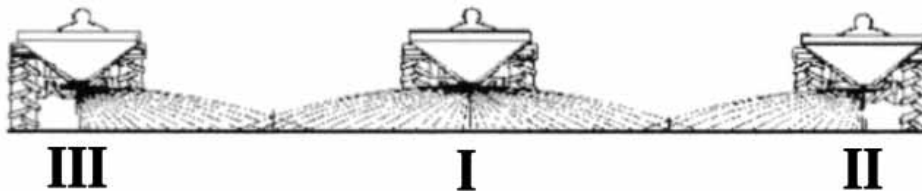

In order to carry out the spreading only through the left side (ref. II), it is necessary to disconnect the two levers removing the "C" grip handle, to set the lever "A" in the chosen position, given by the spreading chart, and to bring the lever "B" towards the higher part (position 1) in order to close the shutter of the right side.

In order to spread only on the right side (ref. III) you have to move the lever "A" up, (in position 1) and regulate the quantity to spread with the lever "B".

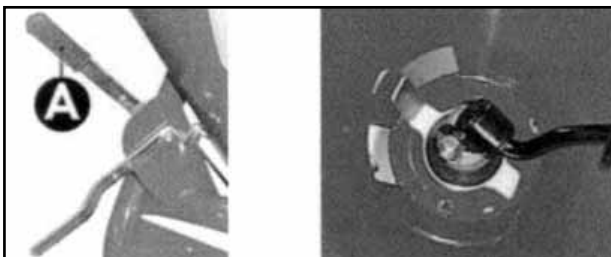

Distribution on right side (ref. III)

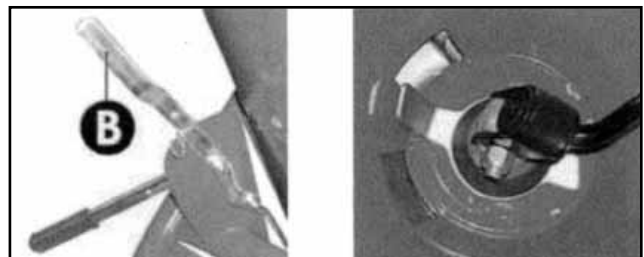

Distribution on left side (ref. II)

SPREADING CHART

SPREADING CHART

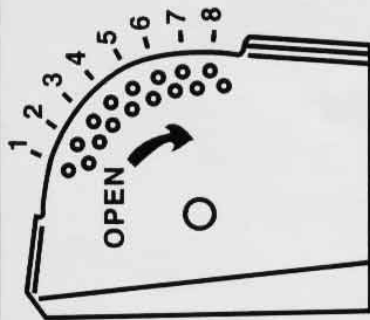

SPREADING CHART FOR SEED

	TRACTOR SPEED (MPH)	WORKING WIDTH (FEET)	QUANTITY SPREAD IN LBS./ACRE AT VARIOUS GATE SETTINGS							
			5	6	7	8				
WHEAT	3	52	0	46	129	268				
	5		0	28	77	161				
ALFALFA & CLOVER	3	31	43	163	340	645				
	5		26	98	204	387				
FESCUE & RYEGRASS	3	19	0	0	85	161				
	5		0	0	51	97				
RED CLOVER	3	31	44	167	333	642				
	5		26	100	200	385				
KENTUCKY BLUE GRASS & BERMUDA GRASS	3	12	30	131	311	660				
	5		18	78	186	396				
SUDAN GRASS	3	52	0	49	131	271				
	5		0	29	79	163				
BARLEY	3	49	0	25	81	186				
	5		0	15	49	111				
RYE	3	40	0	25	81	186				
	5		0	15	49	111				

SPREADING CHART FOR FERTILIZER

	TRACTOR SPEED (MPH)	WORKING WIDTH (FEET)	QUANTITY SPREAD IN LBS./ACRE AT VARIOUS GATE SETTINGS							
			2	3	4	5	6	7	8	8.5
LARGE GRANULAR FERTILIZER	2,5	132	245	402	635	929	1014	1140	1248	
	5,0	66	123	201	318	465	507	570	624	
	7,5	44	82	134	212	310	338	380	416	
MEDIUM GRANULAR FERTILIZER	2,5	—	311	448	709	925	1025	1118	1182	
	5,0	—	156	224	355	463	513	559	591	
	7,5	—	104	149	237	309	342	373	394	
FINE GRANULAR FERTILIZER	2,5	112	189	322	529	747	842	963	1051	
	5,0	56	95	166	265	374	421	482	526	
	7,5	37	63	111	177	249	280	321	351	
CRYSTAL (AMMON. SILPHATE)	2,5	226	368	560	890	1236	1354	1522	1632	
	5,0	113	184	280	445	618	677	761	816	
	7,5	75	123	187	297	412	451	507	544	
THOMAS MEAL (BASIC SLAG)	4,0	20	—	—	571	—	1270	—	1685	—
	8,0	—	—	—	286	—	635	—	843	—

ADJUSTMENT

- **ADJUSTMENT**

It is not possible to have an exact spreading chart for equipment that makes use of the centrifugal principle, as the distributed quantity depends on the speed, on the radius of distribution, on the quality and humidity of the fertilizer, and on the roughness of the land.

The fertilizer must always be stored and conserved adequately, so as to keep its physical characteristics unchanged.

- **HOW TO ADJUST THE SPREADER VANES**

The disc vanes can be set in 4 different positions. Position #1 increases the distribution to the left. Position #4 increases the distribution to the right. For normal even spreading, use holes #2 and #3.

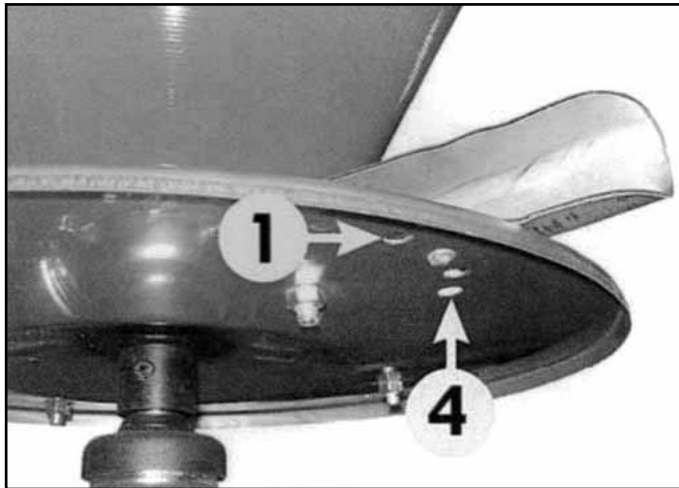

Spreading disc's vanes settings

FEATURES & OPTIONS

The spreaders are equipped with a stainless steel disc with 4 adjustable vanes in 4 different positions. The vanes are bolted in place in the most used position.



Spreader Disc

The feeding of the disc is by gravity through an opening, located on the bottom of the hopper, inside of which a mix/agitator is applied, in order to prevent the fertilizer lumps formation. A sheet case is placed in front of the disc, in order to prevent the spreading in the front side of the machine.

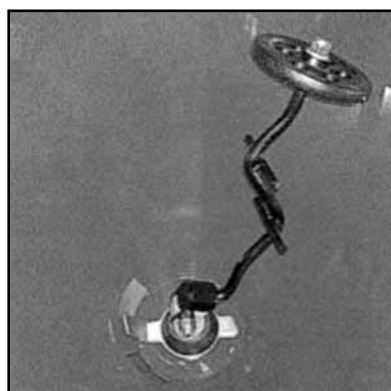

Optional Agitator

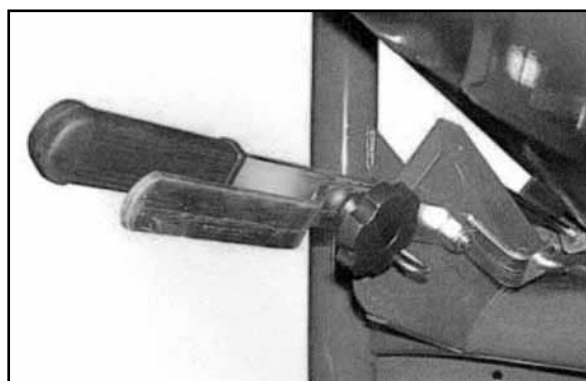

Lever System

If the material you are spreading does not flow evenly, a longer optional agitator is available.

If band spreading on rows is required, a one or two row band spreading attachment is available. This attachment is easy to bolt up to all models of our 3-point hitch spreaders.

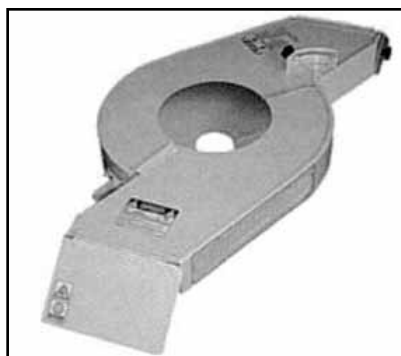

LUBRICATION & SERVICE

Before every use and after every 8 hours of effective work, carry out the greasing of the machine.

Make sure the greasing zerks are well cleaned from mud or other residuals before using them to inject lubricating grease. Lubricate with lithium grease the points, shown in the picture.

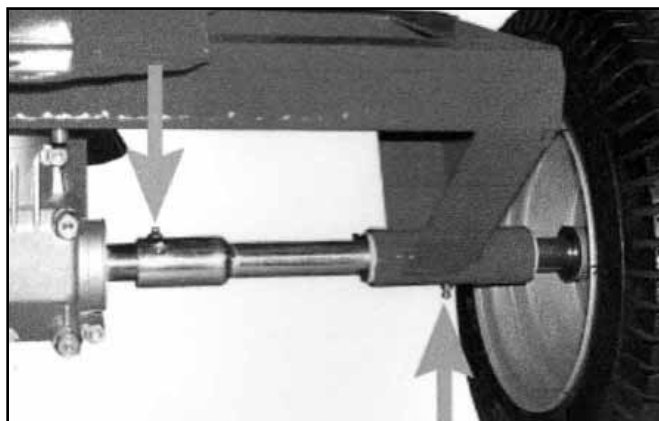
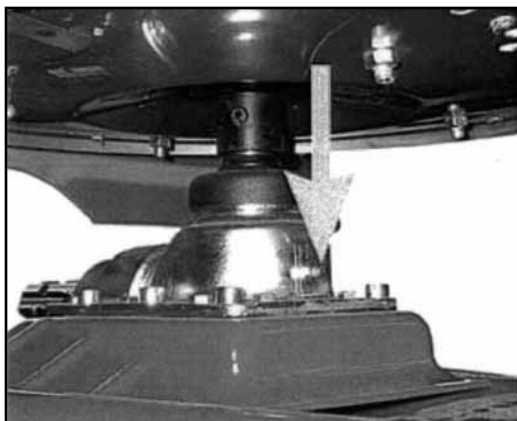

Point to grease

REPLACEMENT OF THE SPREADER VANES

In case the spreading vanes of the disc break or get damaged, it is necessary to replace them with new ones.

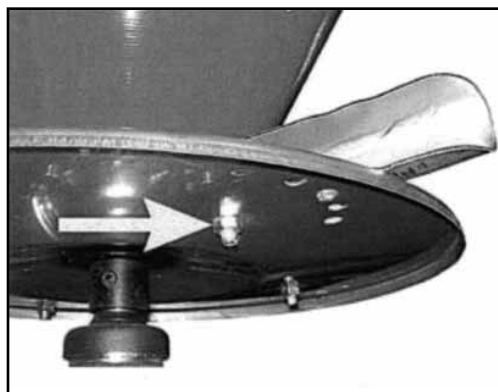

Unscrew the nut and replace the damaged vane.

The fixing items (nuts and bolts) must be of the same type as those provided from the manufacturer.

OPERATION

HOPPER LOAD:

It is advised not to carry out the hopper loading manually but by using suitable mechanical means.



ATTENTION! The hopper must be loaded only after having hitched the spreader to ATV.

Do not drive for very long distances with a full load and do not put full bags of the fertilizer loaded in the hopper during the transport to the field or during the working, in order not to overload the capacity of the machine and to compress the fertilizer.



WARNING! During the operations of transport, stock and use of fertilizers, the operator must be in compliance with the indications on the label of the product and in particular with the content of the sentences of risk and the advised precautions.

SPREADING OF THE FERTILIZER IN THE FIELD:



ATTENTION! - WARNING! The operator, during the period of use, maintenance, repair, transport or storing of the machine, must wear accident prevention shoes and gloves. If it is necessary, he will have, moreover, to wear headset, mask and glasses.

After having hitched the machine to the tractor and having carried out the necessary regulations, it is possible to begin work.



ATTENTION! Before getting off from the ATV and before every operation of maintenance and regulation, set in action the parking brake, turn off the engine and remove the ignition key from the dashboard and wait for all moving parts to stop.

Engage the axle with the pin, so that the spreader can be set in action by the turning wheels, only in the moment in which the spreading operation has to be carried out.

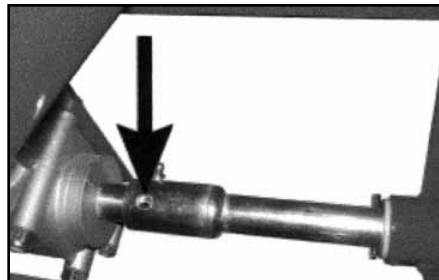

SPREADING IN FIELDS



Various ways exist to spread the fertilizer in the field. One of the simplest methods is as follows:

1. Position the ATV/tractor at the beginning of the field you intend to fertilize, to a distance ($D/2$) that is half of the working width that is used (point 1).
2. Drive into the field distributing the fertilizer on all the perimeter.
3. Stop the tractor at one distance (D) from the point 1, equivalent to the set working width (point 2).
4. Begin the spreading proceeding in line, straight to point 3.
5. Turn the tractor and drive a D distance, equal to the working width (point 4).
6. Repeat such procedure until all the plot will be covered.

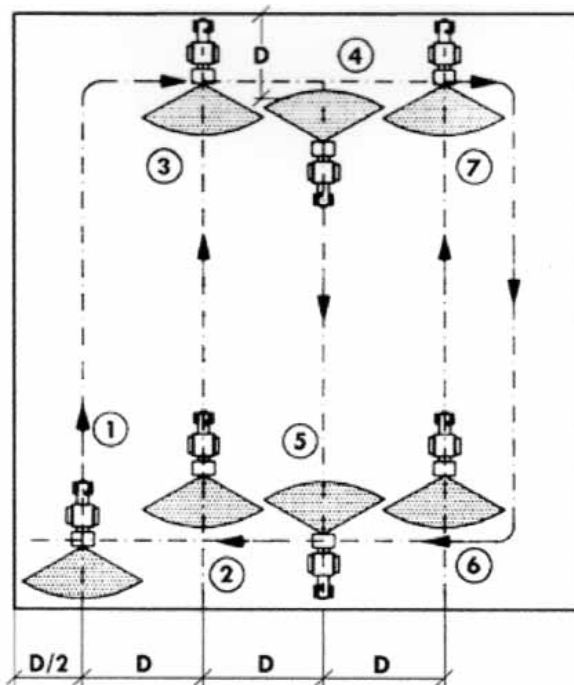

PARTS BREAKDOWN

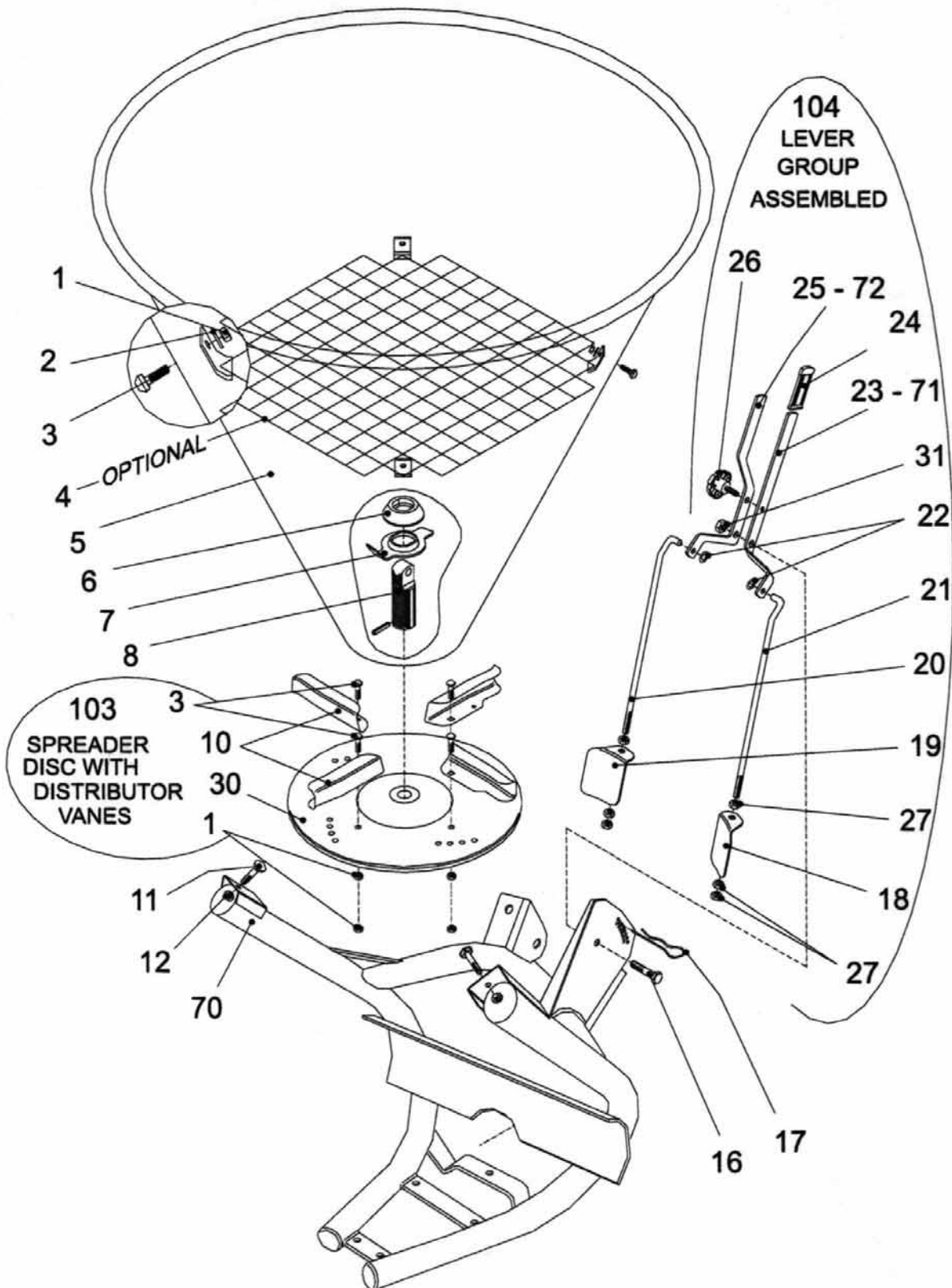

PARTS BREAKDOWN

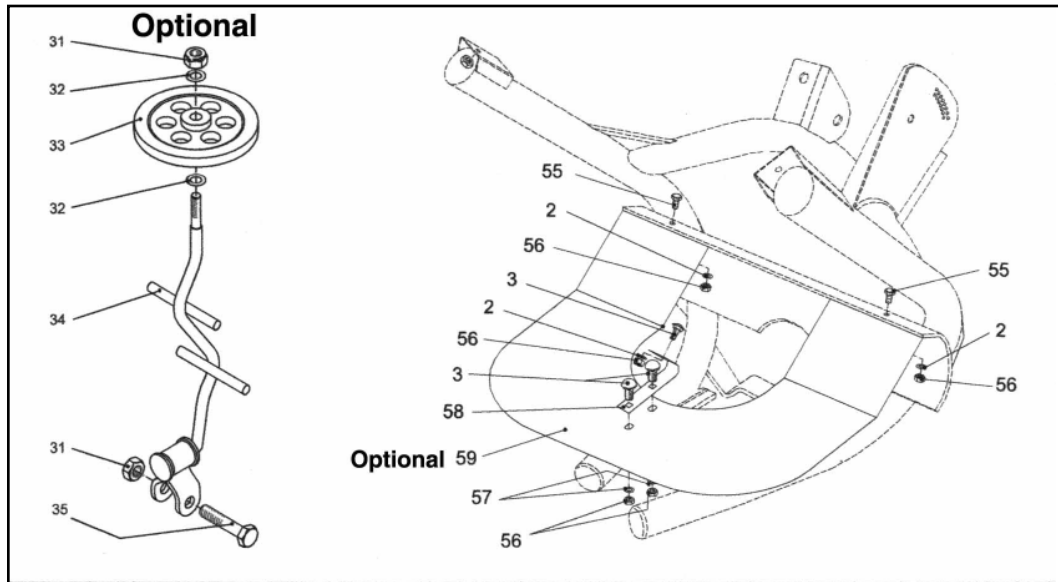
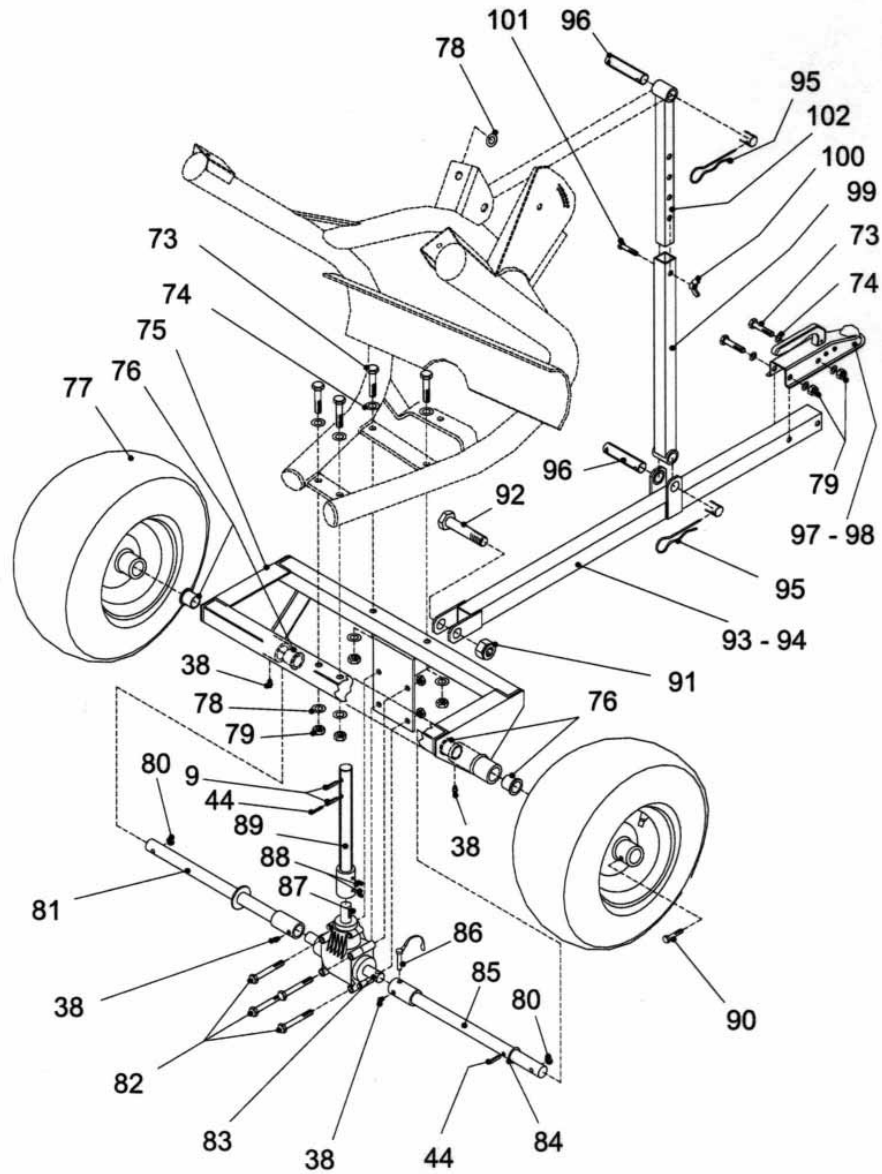

PARTS LIST

<u>REF #</u>	<u>QTY.</u>	<u>PART NO.</u>	<u>DESCRIPTION</u>
1	4	301.012	Nut M8 UNI 5588
1	4	301.012	Nut M8 UNI 5588 (for grill)
2	3	303.007	Washer 8 x 17 UNI 6592
2	4	303.007	Washer 8 x 17 UNI 6592 (for grill)
3	7	300.030	Screw TTQST 8 x 16 UNI 5731
3	4	300.030	Screw TTQST 8 x 16 UNI 5731 (for grill)
4	1	642.001	Protective Grill CE
5	1	609.008	Hopper 180
5	1	609.038	Plastic Hopper 180
5	1	609.011	Hopper 300
5	1	609.033	Plastic Hopper 300
6	1	304.013	Rubber Ring
7	1	619.002	Lower Agitator
8	1	330.001	Entrainer
9	2	305.001	Spring Pin 8 x 40
10	4	601.001	Distributor Vane
11	3	300.023	Screw TTQST 10 x 20 UNI 5731
12	3	301.010	Nut M10 UNI 5588
16	1	300.024	Screw TE 12 x 35 UNI 5739
17	1	307.001	Split Pin 4.5
18	1	605.004	Left Shutter
19	1	605.003	Right Shutter
20	1	602.001	Right Tie Rod
21	1	602.002	Left Tie Rod
22	2	303.009	Flat Washer 10.5 x 21 UNI 6592 GR
23	1	604.002	Left Lever Short Version
71	1	604.005	Right Lever Long Version
24	1	304.008	Rubber Grip
25	1	604.001	Right Lever Short Version
72	1	601.006	Left Lever Long Version
26	1	302.003	Lever Lock Knob 8 x 25
27	6	301.014	Nut M10 UNI 5589 GR
30	1	610.003	Spreader Disc Without Vanes
30	1	610.013	Stainless Steel Disc Without Vanes
31	1	301.008	Self Locking Nut M12
38	4	306.002	Grease Nipple M8
44	2	305.003	Spring Pin 5 x 40
55	2	300.029	Screw TE 8 x 20 UNI 5739
56	5	301.012	Nut M8 5588
57	2	303.013	Washer 8 x 24 UNI 6593
58	1	606.009	Support Bracket
59	1	606.010	Sheet Guard
70	1	613.026	PTP Frame

PARTS LIST

<u>REF #</u>	<u>QTY.</u>	<u>PART NO.</u>	<u>DESCRIPTION</u>
73	6	300.020	Screw TE 10 x 70 UNI 5737
74	8	303.015	Washer 10 x 20 UNI 6592
75	1	613.025	PTP Support Frame
76	4	325.024	Smooth Bearing w/Flange
77	2	620.079	PTP Tire
78	5	303.025	Washer 10 x 30 UNI 6593
79	10	301.013	Self Locking Nut M10
80	2	301.001	Self Locking Nut M8
81	1	620.082	PTP Right Axle
82	4	300.018	Screw TE 10 x 100 UNI 5737
83	1	322.008	Gearbox Without PTO
84	1	303.035	Washer 25 x 351.5
85	1	620.083	PTP Left Axle
86	1	302.006	Pin MM8
87	1	326.003	Key 8 x 7 x 20
88	2	305.015	Dowel M6
89	1	323.013	Output Shaft with Bushing
90	2	300.027	Screw TE 8 x 50 UNI 5737
91	1	301.006	Self Locking Nut M22
92	1	300.021	Screw TE 22 x 80 UNI 5739
93	1	613.030	Tow Tube For 1 7/8" Hook
94	1	613.031	Tow Tube For 2" Hook
95	2	305.008	Spring Pin R 3
96	2	633.003	PTP Pivot Dia. 22
97	1	620.080	Tow Hitch 1 7/8"
98	1	620.090	Tow Hitch 2"
99	1	606.061	Outer Tube Level Stop With Bushing
100	1	301.005	Tongue Nut M8
101	1	300.019	Screw TE 8 x 40 UNI 5737
102	1	606.060	Inner Tube Level Stop With Bushing
103		610.001	Spreader Disc With Vanes
103		610.014	Stainless Steel Disc With Vanes
104		618.006	Lever Group Assembled RH & LH Short Version
104		618.013	Lever Group Assembled RH & LH Long Version
		619.004	Agitator PTP Model

LIMITED WARRANTY



GEARMORE, INC., warrants each new Gearmore product to be free from defects in material and workmanship for a period of twelve (12) months from date of purchase to the original purchaser. This warranty shall not apply to implements or parts that have been subject to misuse, negligence, accident, or that have been altered in any way.

Our obligation shall be limited to repairing or replacement of any part, provided that such part is returned within thirty (30) days from date of failure to Gearmore through the dealer from whom the purchase was made, transportation charges prepaid.

This warranty shall not be interpreted to render us liable for injury or damages of any kind or nature, direct, consequential or contingent, to person or property. This warranty does not extend to loss of crops, loss because of delay in harvesting or any other expenses, for any other reasons.

Gearmore in no way warrants engines, tires, or other trade accessories, since these items are warranted separately by these respective manufacturers.

Gearmore reserves the right to make improvements in design or changes in specification at any time, without incurring any obligations to owners or units previously sold.

GEARMORE, INC.
13477 Benson Ave.
Chino, CA 91710

Always refer to and heed machine operating warning decals on machine.

The serial number of this product is stored in our computer database, thus submitting a warranty registration card is not required.

CUSTOMER INFORMATION

NAME: _____

PURCHASED FROM: _____

DATE OF PURCHASE: _____

MODEL NUMBER: _____

SERIAL NUMBER: _____