

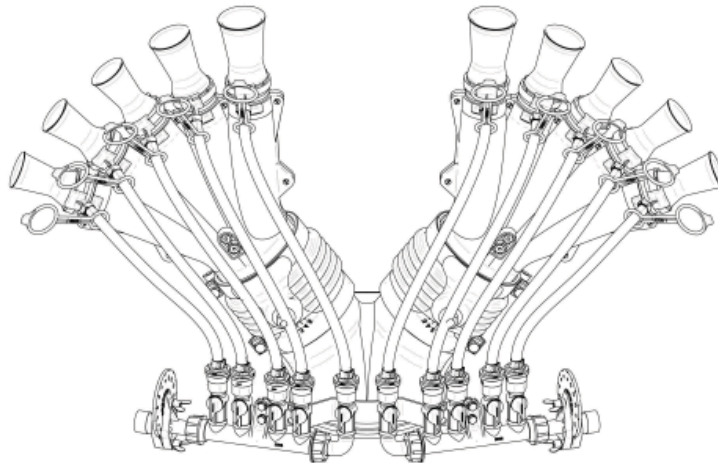

VENTURI AIR SPRAYERS VINEYARD HEAD



**Parts Manual For
T5+54512 Head
For P45 & T45 Sprayers**

July 2013

TABLE OF CONTENTS

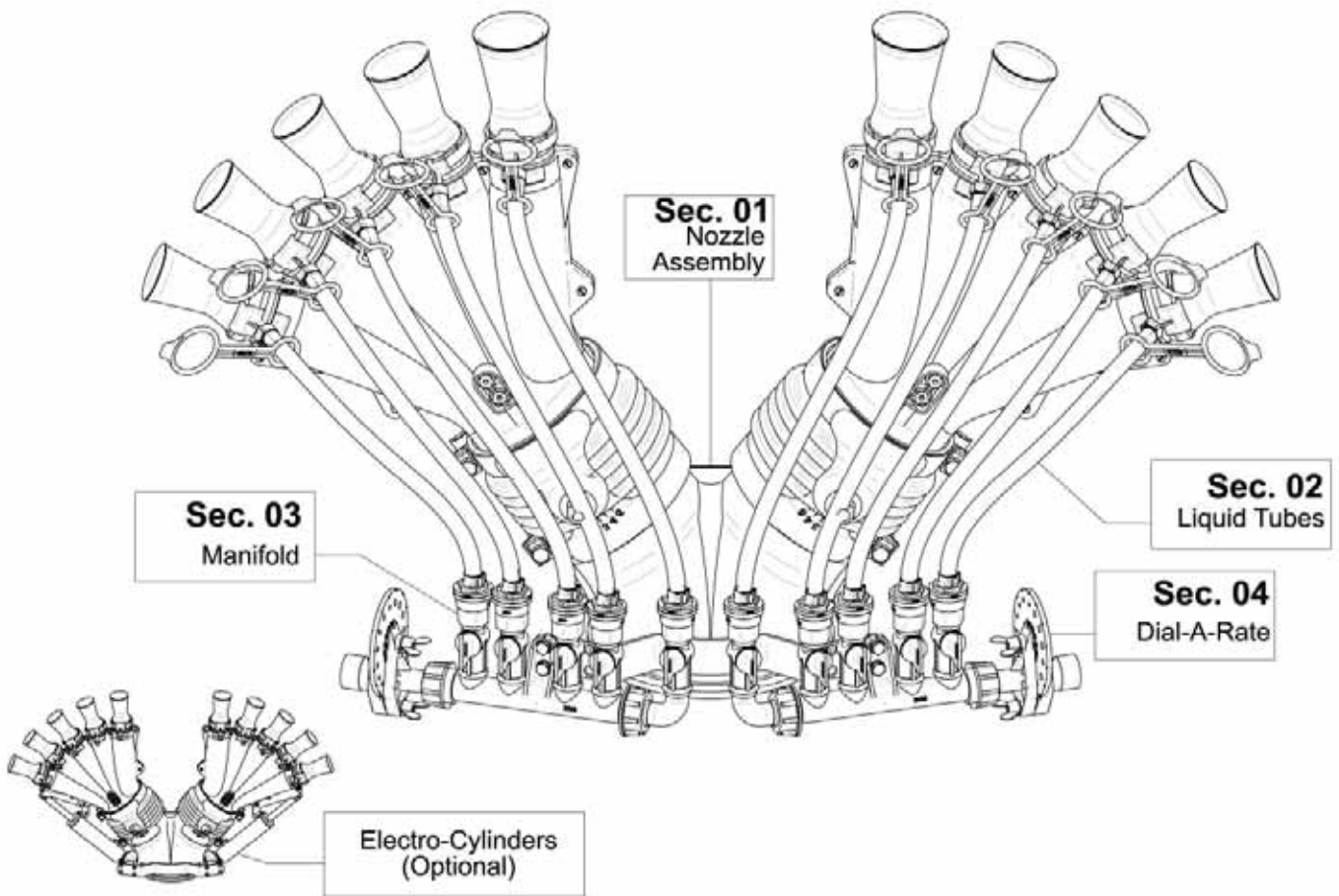

<u>SECTION</u>	<u>DESCRIPTION</u>	<u>PAGE</u>
1	Nozzle Parts	1
2	Liquid Parts - Right Hand.....	2
	Liquid Parts - Left Hand	3
3	Manifold & Shut-Off Valves.....	4
4	Dial-A-Rate	5

Sec. 01 - NOZZLE PARTS

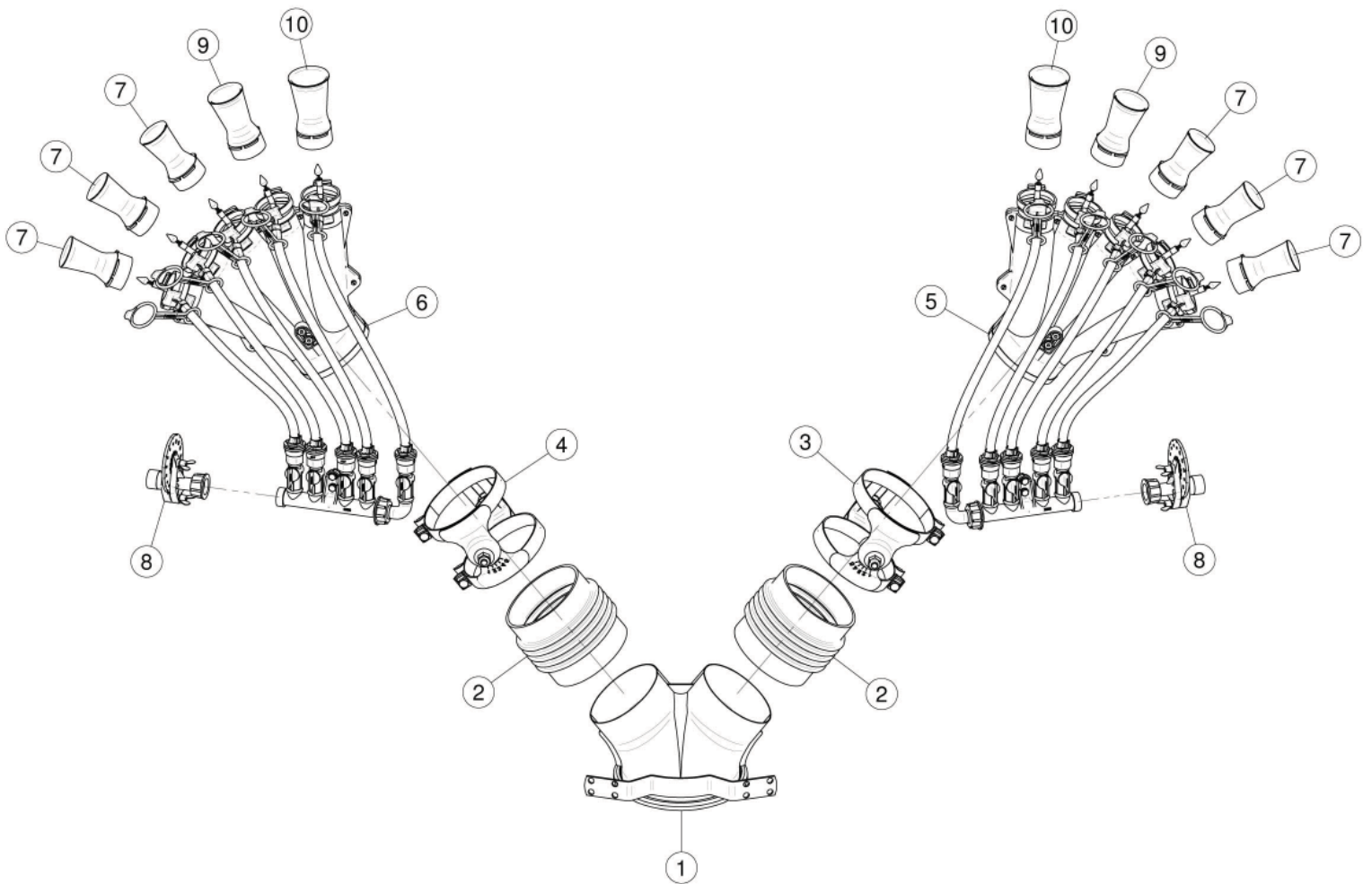

<u>REF.</u>	<u>QTY.</u>	<u>PART NO.</u>	<u>DESCRIPTION</u>
1	1	02.739.000	Body Head
2	2	02.021.000	Flexible Sleeve
3	1	21.080.000	Right Clamp Ø 127
4	1	21.081.000	Left Clamp Ø 127
5	1	20.015.305CDX	Five Outlets With Distributor
6	1	20.015.305CSX	Five Outlets With Distributor
7	6	00.006.050	Nozzle 6/50
8	2	02.150.000	Rotation Disk Regulation
9	2	00.008.050	Nozzle 8/50
10	2	00.010.050	Nozzle 10/50

Sec. 02 - LIQUID PARTS - RIGHT HAND

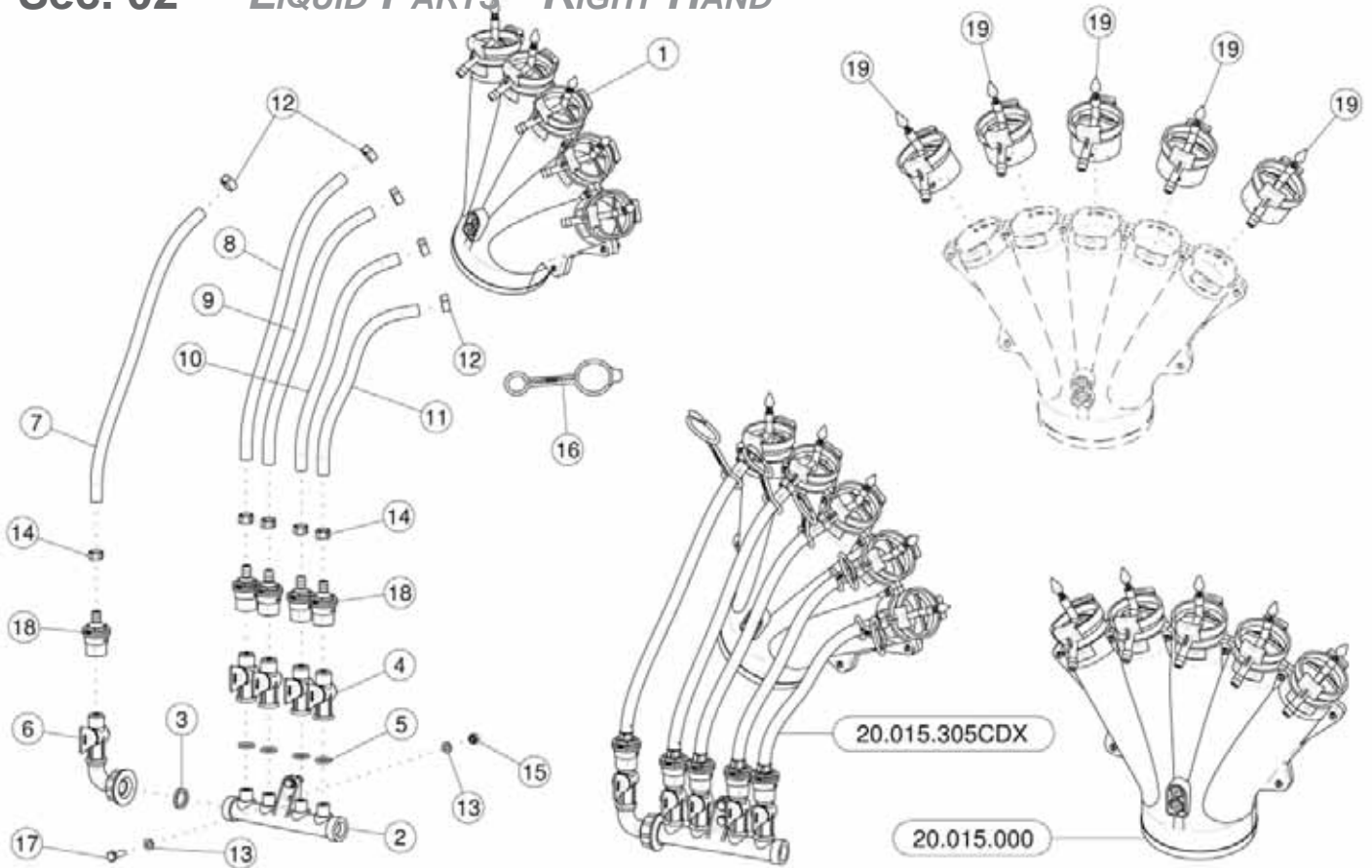

<u>REF.</u>	<u>QTY.</u>	<u>PART NO.</u>	<u>DESCRIPTION</u>
20.015.305CDX			
1	1	20.015.000	Five Outlets With Pipes
2	1	02.008.000	Sprayheads Liquid Manifold
3	1	02.349.000	17 x 23 x 3 Flat Gasket
4	4	20.202.100	Tap Assembly
5	4	OR.000.117	13.1 x 18.34 x 2.62 O-Ring Gasket
6	1	20.202.102C	Tap Assembly With Elbow
7	As Req'd	02.217.000	Hose D.8 x 13 L=380 (Per Foot)
8	As Req'd	02.217.000	Hose D.8 x 13 L=380 (Per Foot)
9	As Req'd	02.217.000	Hose D.8 x 13 L=380 (Per Foot)
10	As Req'd	02.217.000	Hose D.8 x 13 L=350 (Per Foot)
11	As Req'd	02.217.000	Hose D.8 x 13 L=330 (Per Foot)
12	5	FC.012.5.014	Hose Clamp
13	4	RP.006.000	Washer D.6
14	5	FC.013.5.015	Hose Clamp
15	2	DO.06.5588G	Nut M6
16	5	20.697.000	Nozzle Stop
17	2	TE.006.020T	Screw TE M6 x 20
18	5	00.227.01C	Antidrip Valve
20.015.000			
19	4	20.016.01C	Tube With Liquid Outlet

Sec. 02 - LIQUID PARTS - LEFT HAND

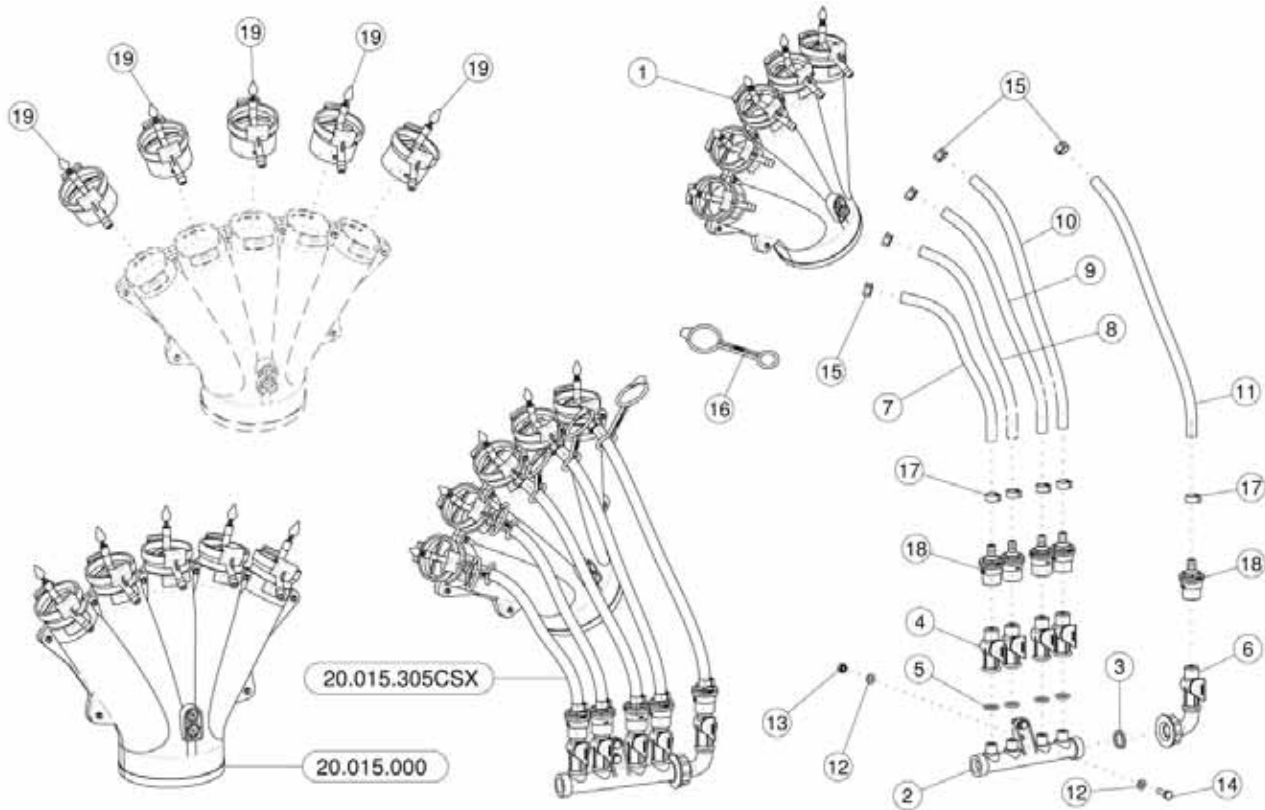

<u>REF.</u>	<u>QTY.</u>	<u>PART NO.</u>	<u>DESCRIPTION</u>
20.015.305CSX			
1	1	20.015.000	Five Outlets With Pipes
2	1	02.008.000	Sprayheads Liquid Manifold
3	1	02.349.000	17 x 23 x 3 Flat Gasket
4	4	20.202.100	Tap Assembly
5	4	OR.000.117	13.1 x 18.34 x 2.62 O-Ring Gasket
6	1	20.202.102C	Tap Assembly With Elbow
7	As Req'd	02.217.000	Hose D.8 x 13 L=330 (Per Foot)
8	As Req'd	02.217.000	Hose D.8 x 13 L=350 (Per Foot)
9	As Req'd	02.217.000	Hose D.8 x 13 L=380 (Per Foot)
10	As Req'd	02.217.000	Hose D.8 x 13 L=380 (Per Foot)
11	As Req'd	02.217.000	Hose D.8 x 13 L=380 (Per Foot)
12	4	RP.006.000	Washer D.6
13	2	DO.06.5588G	Nut M6
14	2	TE.006.020T	Screw TE M6 x 20
15	5	FC.012.5.014	Hose Clamp
16	5	20.697.000	Nozzle Stop
17	5	FC.013.5.015	Hose Clamp
18	5	00.227.01C	Antidrip Valve
20.015.000			
19	4	20.016.01C	Tube With Liquid Outlet

Sec. 03 - MANIFOLD & SHUT-OFF VALVES

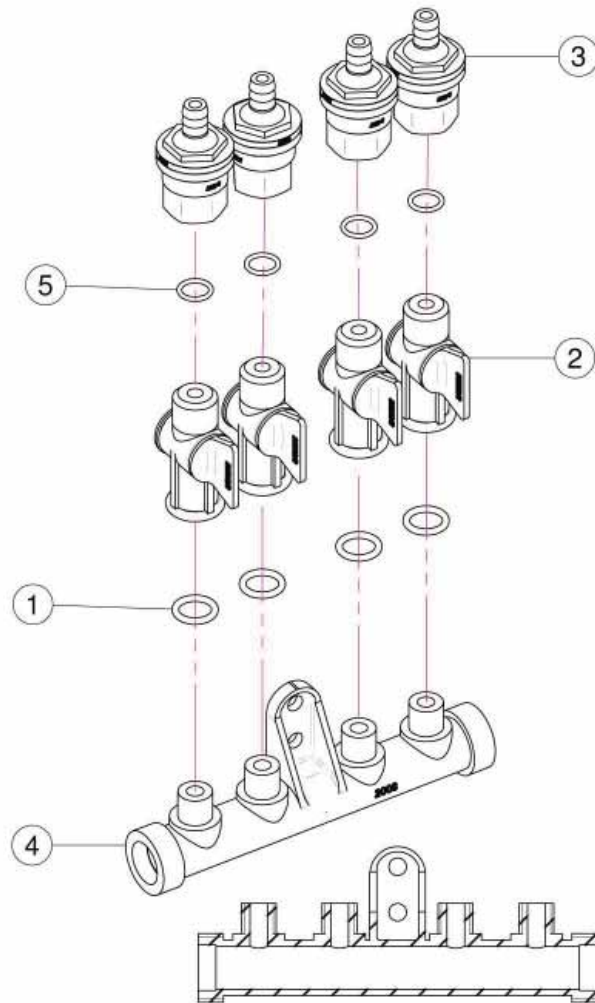

<u>REF.</u>	<u>QTY.</u>	<u>PART NO.</u>	<u>DESCRIPTION</u>
		02.008.304C	Complete Assembly
1	4	OR.000.117	13.1 x 18.34 x 2.62 O-Ring Gasket
2	4	20.202.100	Tap Assembly
3	4	00.227.01C	Anti-Drip Valve
4	1	02.008.000	Sprayheads Liquid Manifold
5	4	OR.002.043	10.82 x 14.38 x 1.78 Nbr 70 O-Ring Gasket

Sec. 04 - DIAL-A-RATE

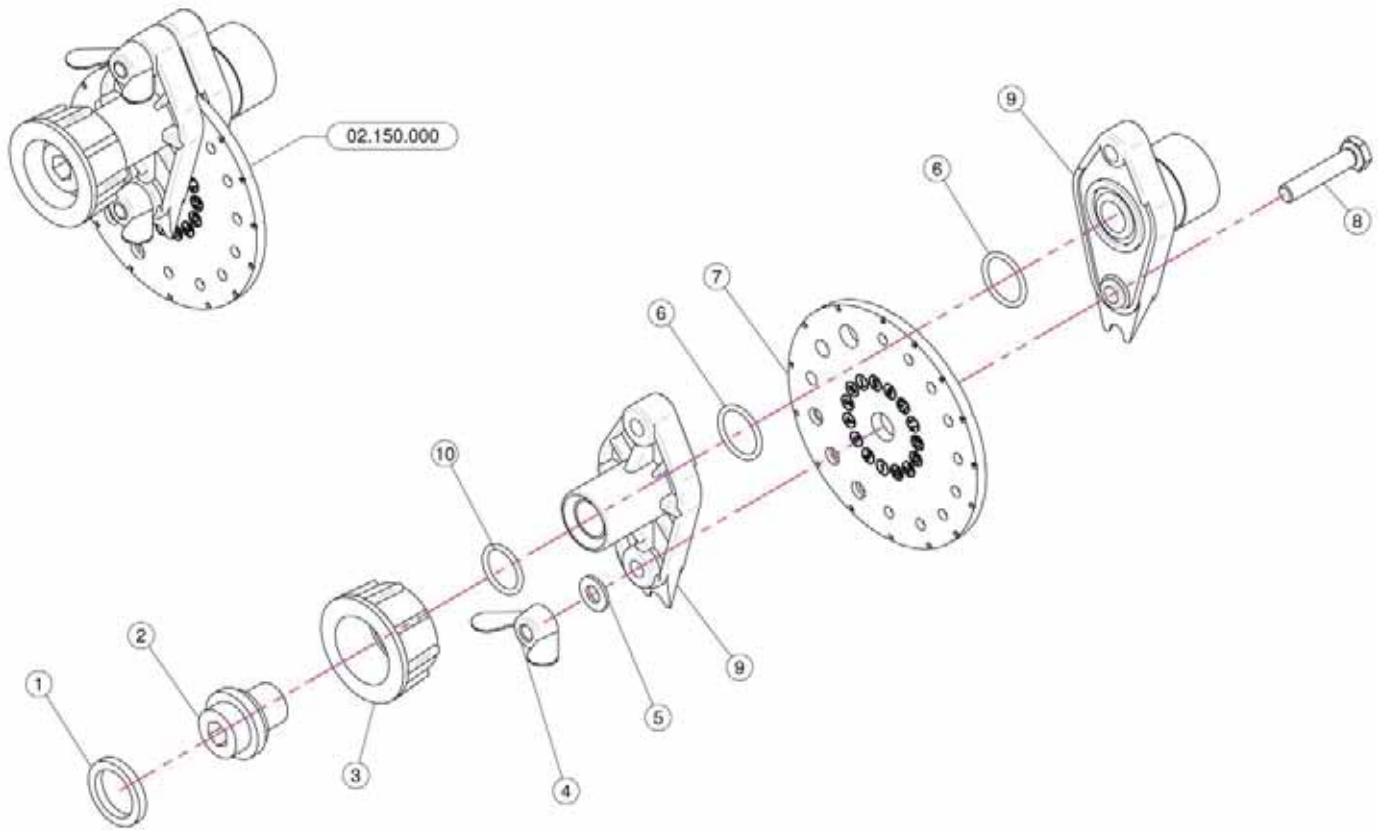

REF.	QTY.	PART NO.	DESCRIPTION
1	1	02.349.000	17 x 23 x 3 Flat Gasket
2	1	02.117.000	Adaptor Nipple
3	1	2002030	3/4" Fly Nut
4	2	DF.OTT.006	Wing Nut M6
5	2	RP.006.000I	INOX Washer D.6
6	2	OR1560178	D.15.6 x 1.78 O-Ring
7	1	02.148.000	Regulator Disc
8	2	TE.006.030I	INOX M6 x 30 Bolt
9	1	02.147.000	Regulator Body
10	1	OR1242178	O-Ring D.12.37 x 2.62